



Specification Data
Self Aligning Rotators
Capacity : From 10 to 300 Tonnes

Red Rock Self Aligning Rotators are robustly designed and built to withstand the harsh and rugged environments expected of such applications and permits rollers to align themselves to the work-piece without the need for manual pre-adjustment irrespective of ovality or irregularity. It uses replaceable polyurethane tyres mounted onto a cast steel drum for durability and superior traction.

On the powered model both tyres are simultaneously driven by an AC gear motor fitted with inverter control box. A hand held low voltage control pendant on a 10-metre cable provides the operator with a full control of the rotator including a potentiometer for varying the speed, start/stop, forward/reverse and emergency stop.

Standard 3170mm base frame length can accommodate vessel diameters ranging from diameter 300mm to 6000mm. Grit blasting to SA 2.5 for all structural steel and polyurethane paintwork will ensure that your investment provides you with many years of uninterrupted use.

The idler roll has the same dimension to match the powered roll.

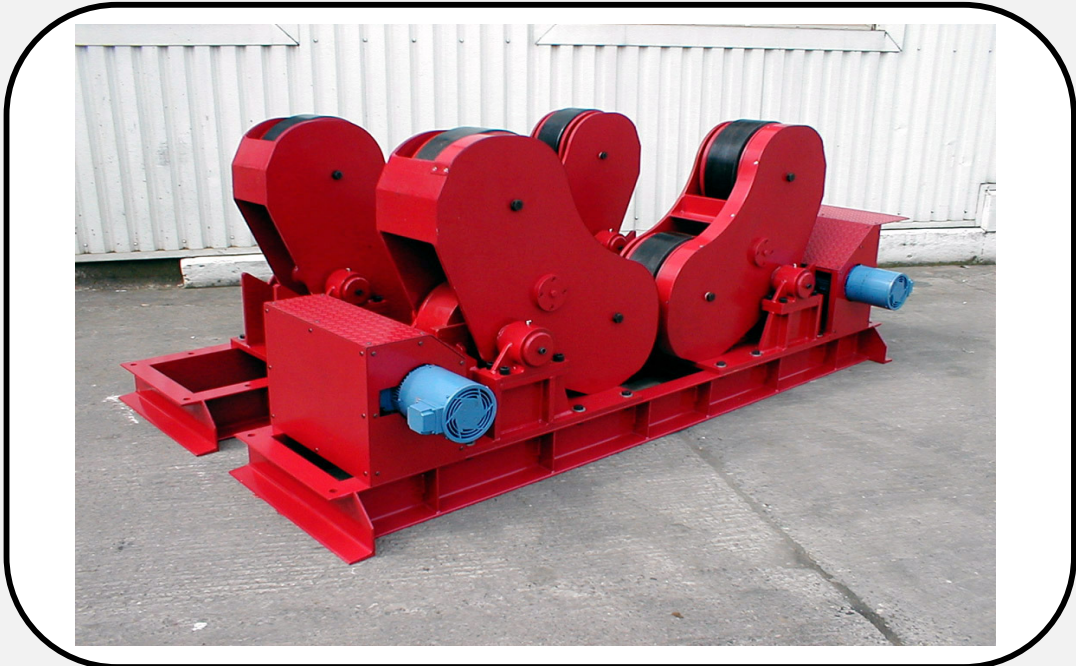

OPTIONAL ITEMS		
Devices	AC- ACM- Y-	Anti-creep device manual Anti-creep device motorised Lead screw type Cadjustment
Additional		
Idler Roll		Skid frame centre to centre
Travel Car	TC- TCM-	Manual travel car Motorised travel car

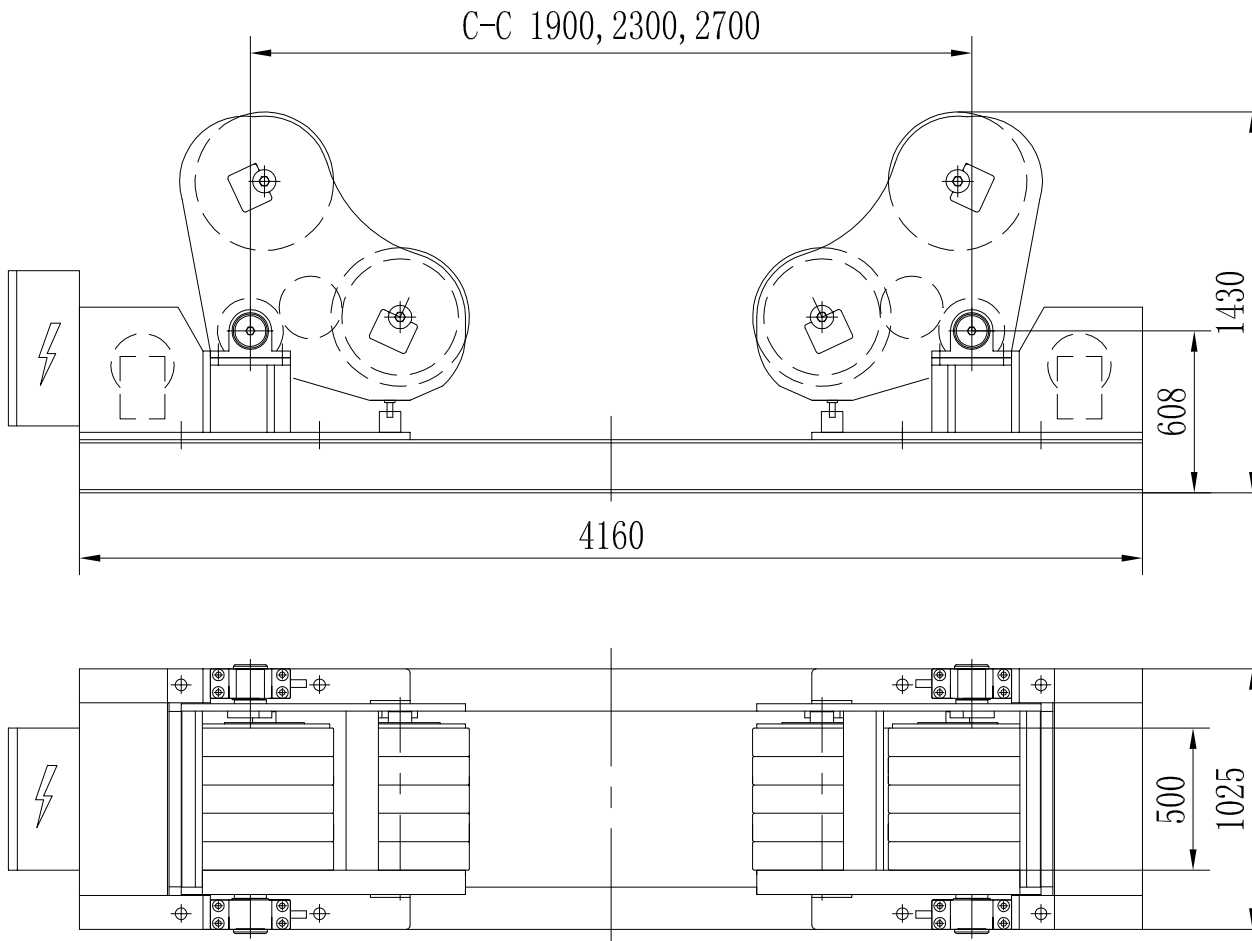

Specification

1	Model	RSPP200-200-27-FM-WE
2	Capacity(loading)	100MT
3	Capacity(turning)	200MT
4	Vessel Size(min)	Ø1000mm at 62° Included Angle, at C-C 1900mm
5	Vessel Size(Max)	Ø7000mm at 38° Included Angle, at C-C 2700mm
6	Tyre/Drum Type and Size	Polyurethane , Ø520mm x 500mm, Shore 'A' 90-95
7	Roller Speed	102-1020mm/min at 5 to 50Hz (Bottom 2 wheels driven only)
8	Incoming Supply	380/400/415V-3P-50Hz or 400/440/460V-3P-60Hz
9	Electrical Panel	Yes
10	Control Voltage	24Vac
11	Roller Drive Control	AC 11KW Inverter
12	Control Means	Via Control Pendant c/w 10m Cable
13	Roller Drive Motor	2 x 5.5kW AC C/W Force cooling (By Others)
14	Surface Preparation	Grit blast to SA2.5
15	Painting	Lead free, 2 Coats Zinc Phosphate, 1 Coat Polyurethane
16	Color	RAL3003 Red & RAL9005 Black for skid and drum
17	Quantity	1
18	Est. Weight of Rotator	6800kg

Note:

- 1) This drawing is accurate at the time of preparation and maybe subject to final design change.
- 2) Input terminals are wired for 400V by default.

ALL DIMENSIONS IN MM, UNLESS OTHERWISE SPECIFIED.



CUSTOMER APPROVAL:

DATE:

CHECKED BY:

DATE:

DRAWN BY: IC

DATE: 05-07-2011

REV	DATE	DESCRIPTION	EDIT BY	REMARKS
CUSTOMER:				
DRAWING NAME: 200T SELF-ALIGNING ROTATOR (POWER)				
DRAWING NO.: QT-11-0020-GA09				
SCALE: N.T.S.				
REV: 0				
THE ORIGINAL AND ALL COPIES OF THIS DRAWING TOGETHER WITH THE COPYRIGHT THEREOF ARE THE SOLE PROPERTY OF RED ROCK. DESIGN AND SPECIFICATIONS ARE SUBJECT TO CHANGE WITHOUT PRIOR NOTICE.				
SHEET: 1 OF 1				